

NAME (Print): _____

SIGNATURE: _____

**Chemistry 320M Review
Dr. Brent Iverson
Practice Homework**

**Please print the
first three letters
of your last name
in the three boxes**

--	--	--

Fill in the boxes with the structures that complete the reactions. Use wedges and dashes to indicate stereochemistry when appropriate.

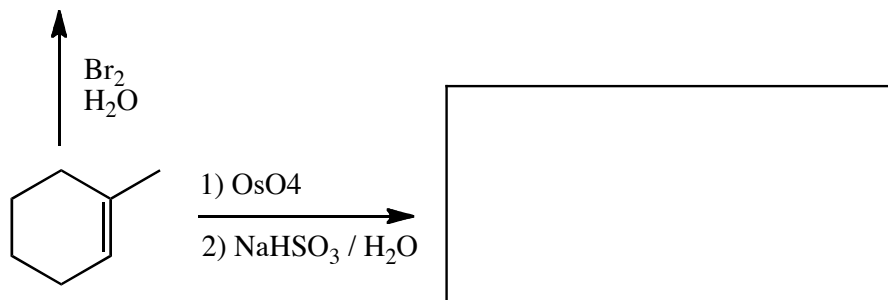
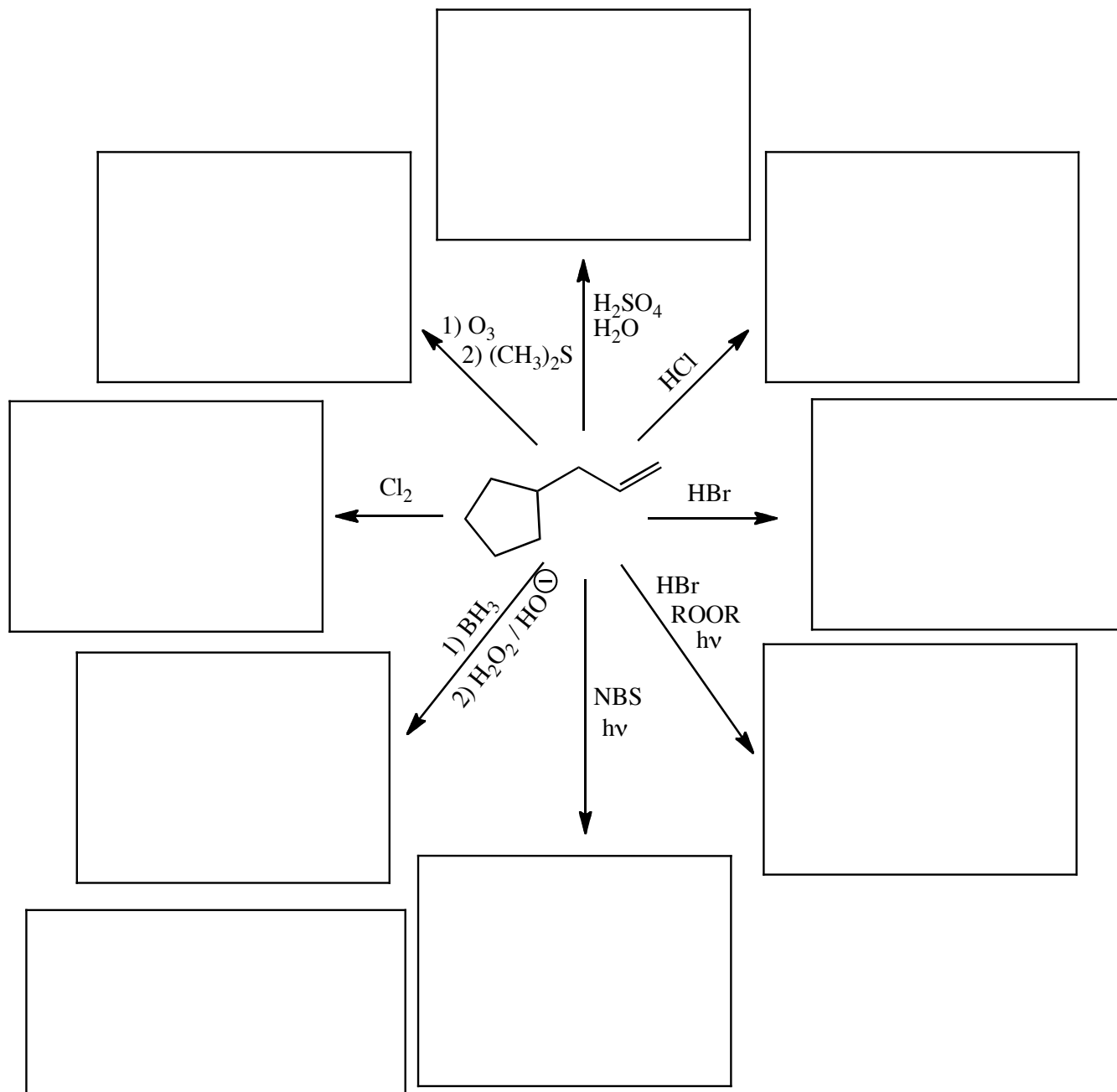

Fill in the boxes with the structures that complete the reactions. Use wedges and dashes to indicate stereochemistry when appropriate.

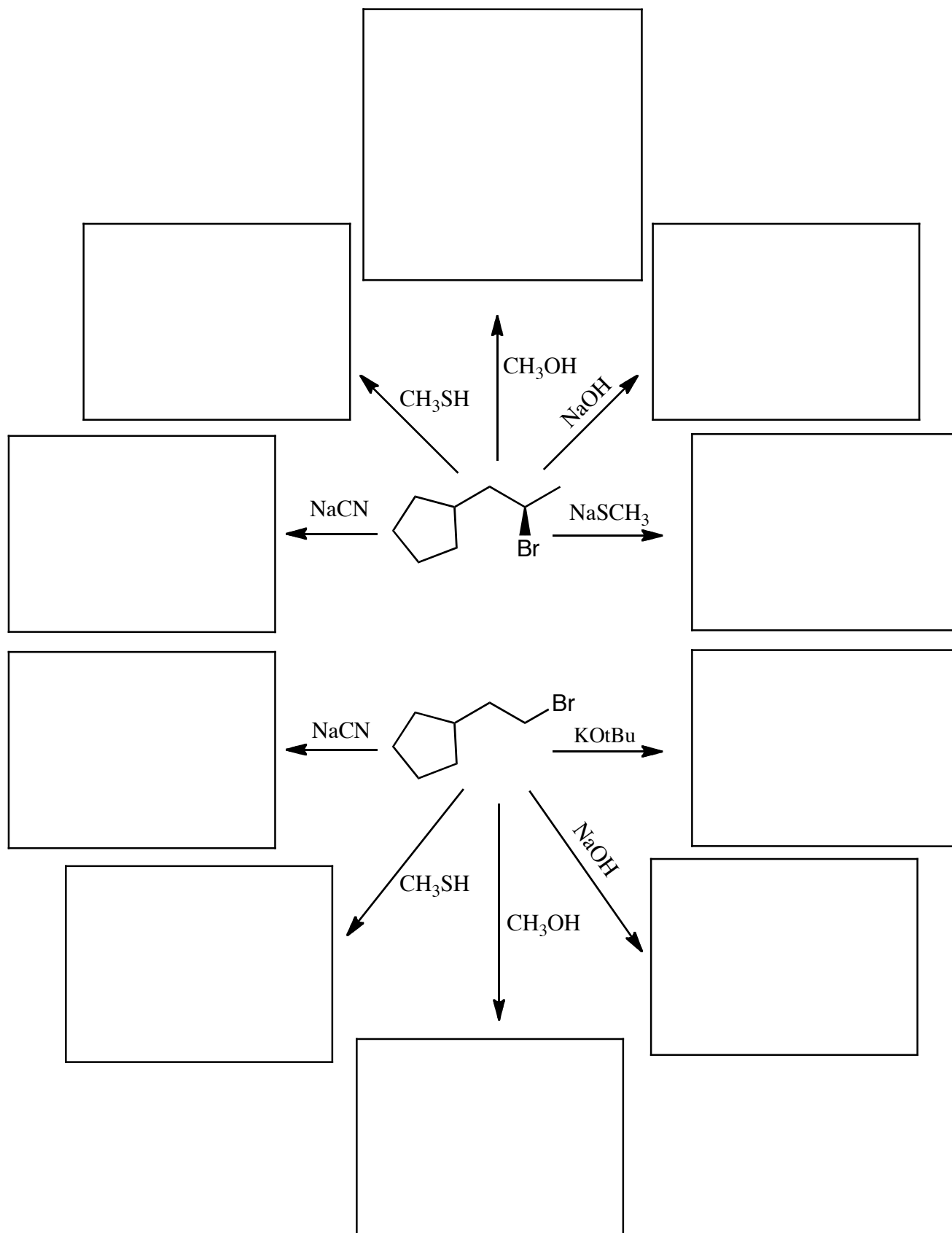

Fill in the boxes with the structures that complete the reactions. Use wedges and dashes to indicate stereochemistry when appropriate.

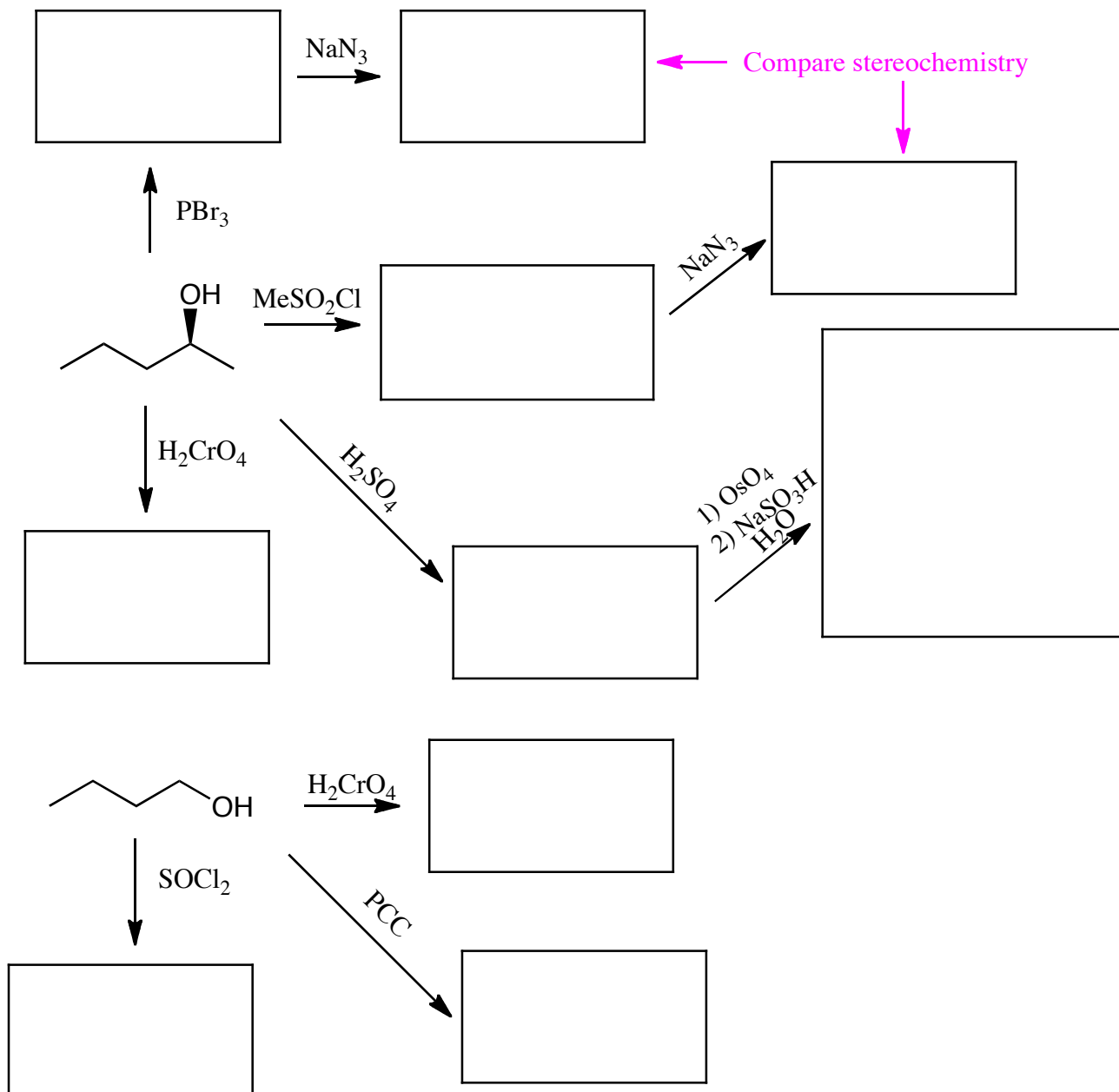

Fill in the boxes with the structures that complete the reactions. Use wedges and dashes to indicate stereochemistry when appropriate.

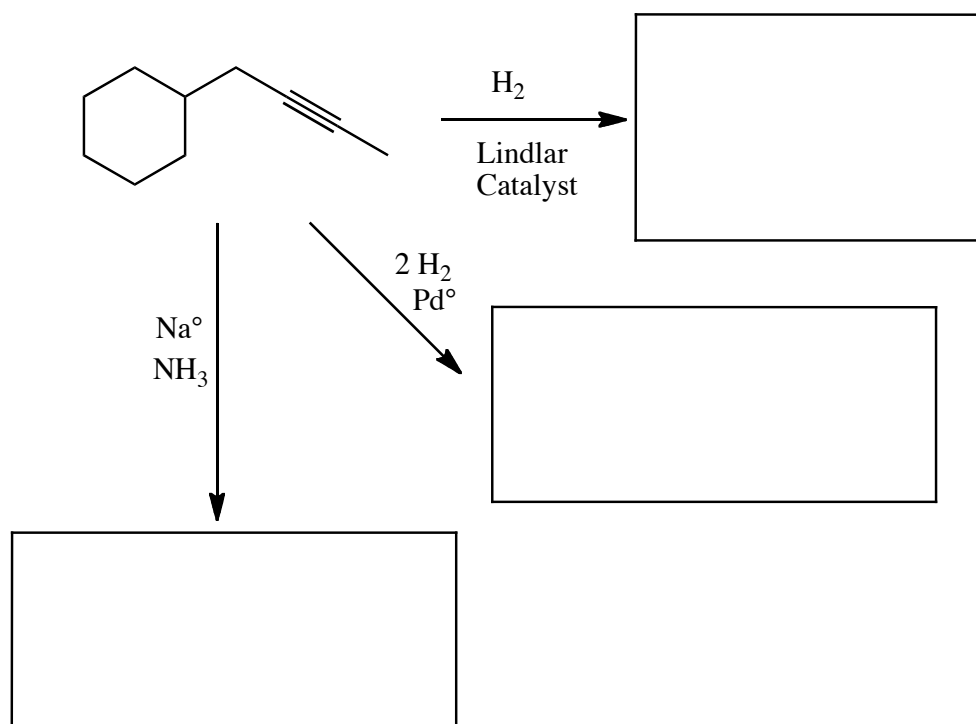
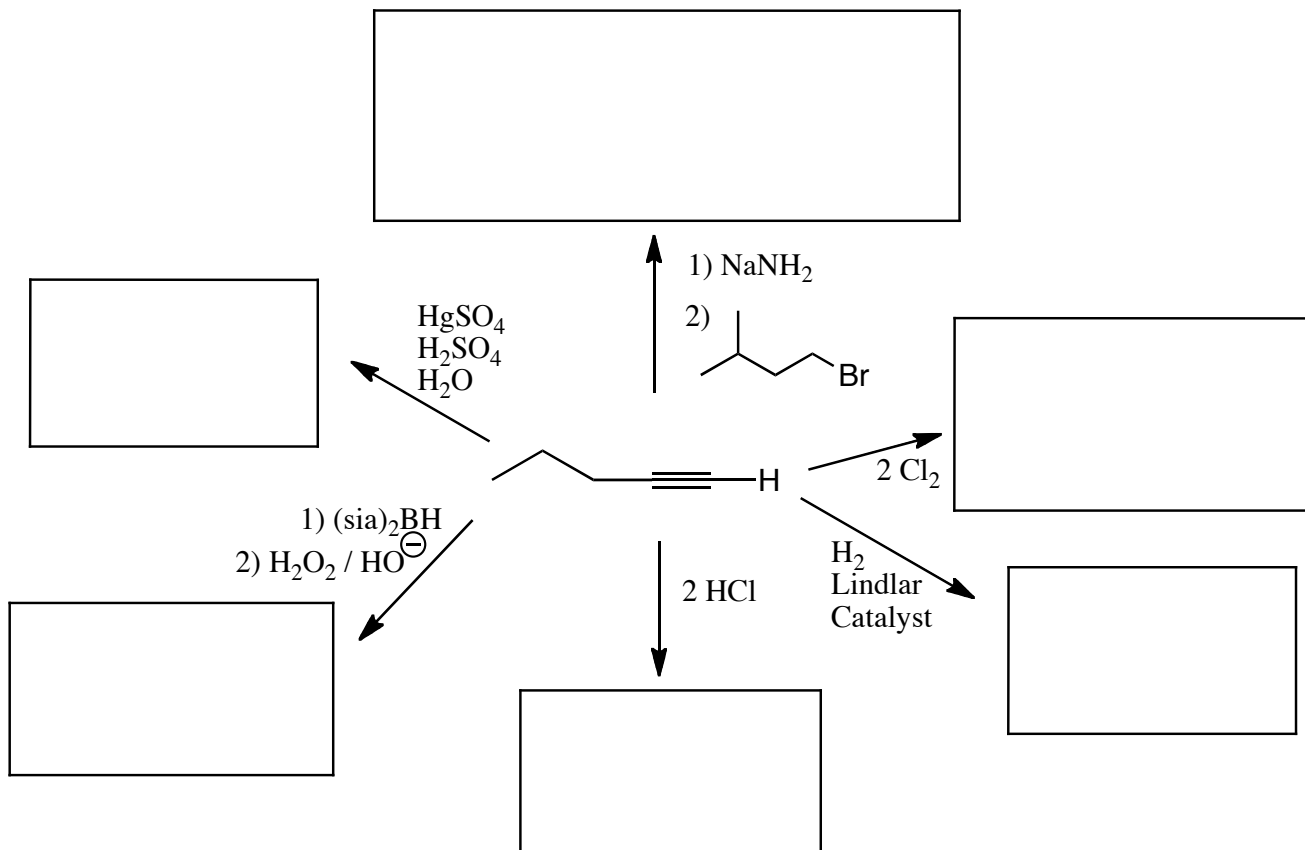

Fill in the boxes with the structures that complete the reactions. Use wedges and dashes to indicate stereochemistry when appropriate. This format is intended to get you more comfortable with working backwards in synthesis problems.

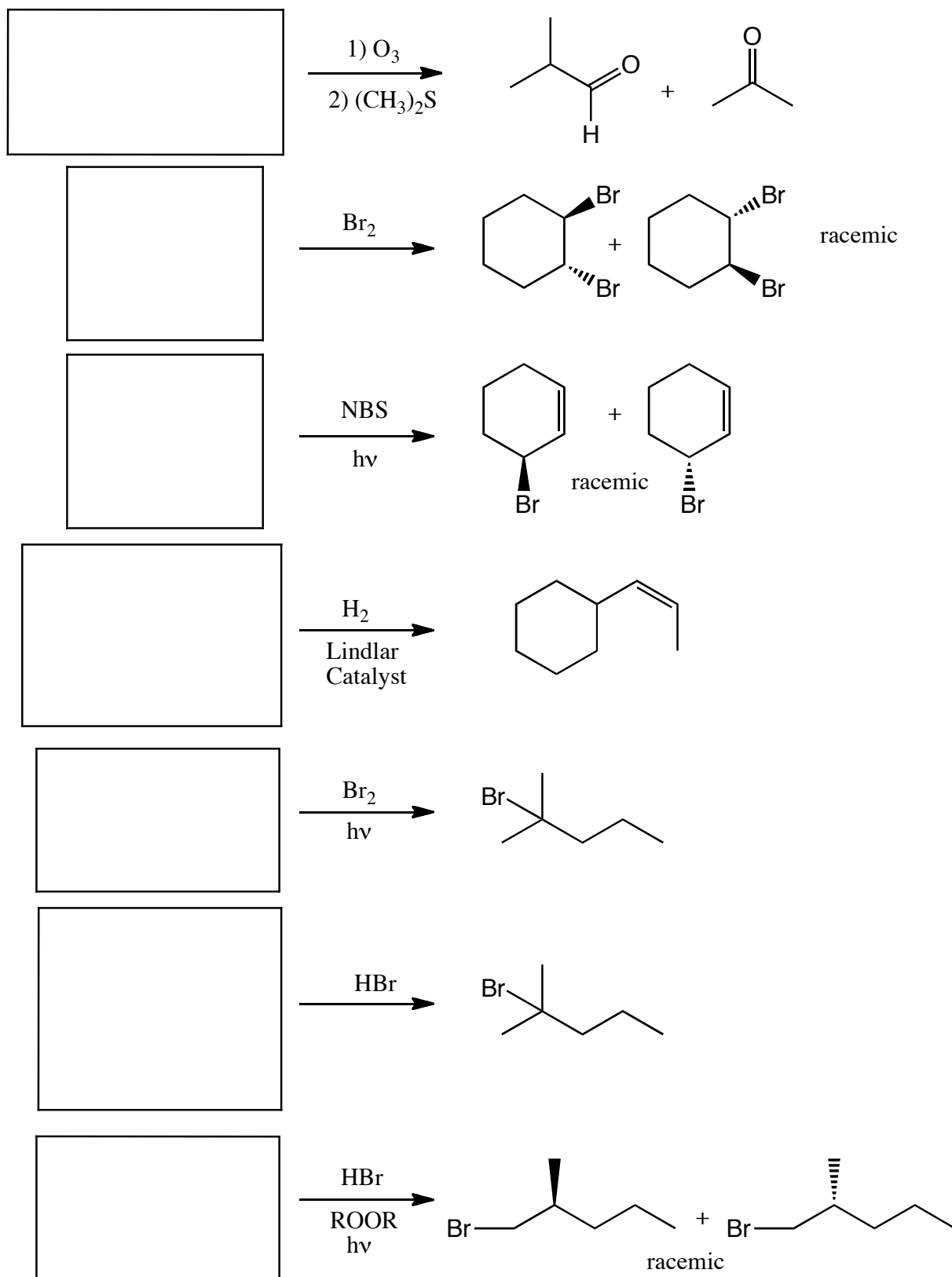

Fill in the boxes with the structures that complete the reactions. Use wedges and dashes to indicate stereochemistry when appropriate. This format is intended to get you more comfortable with working backwards in synthesis problems.

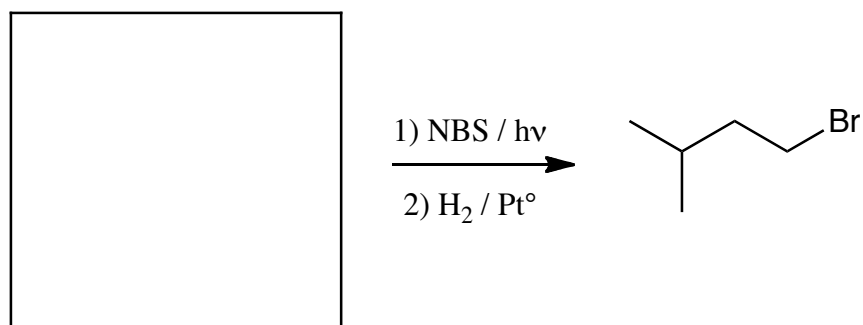
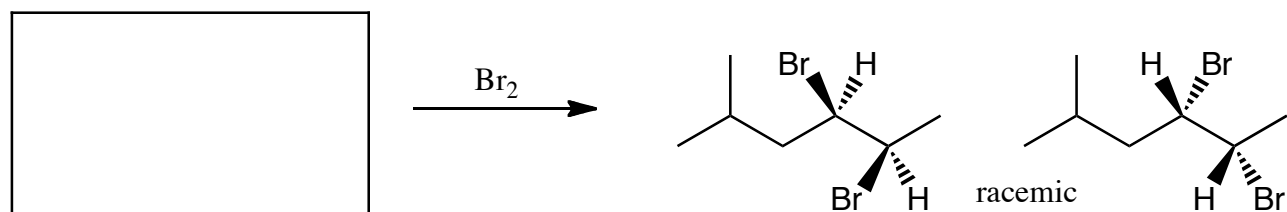
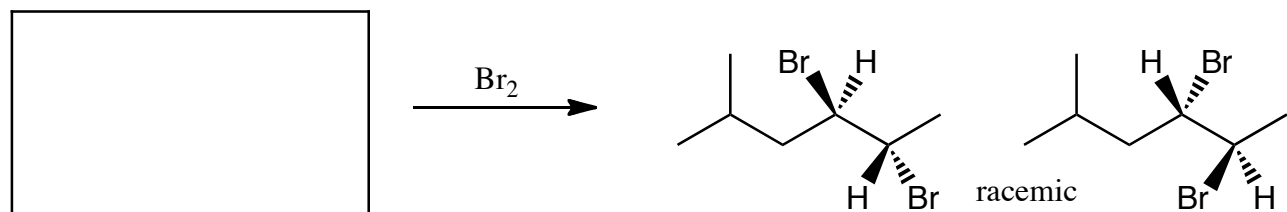
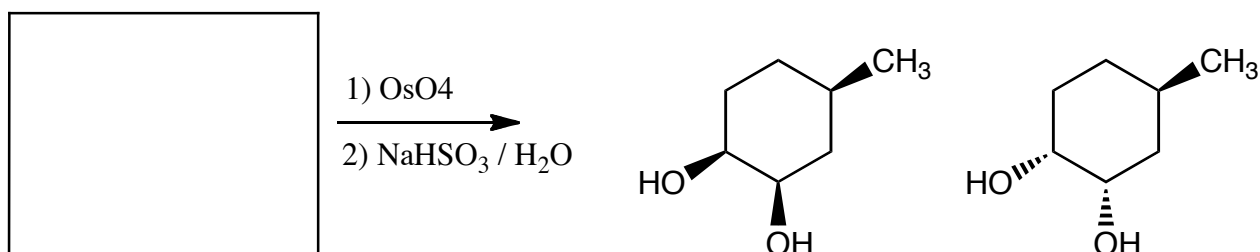
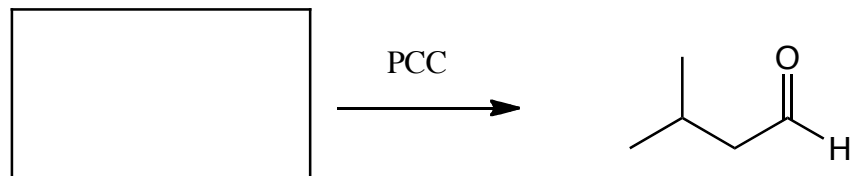
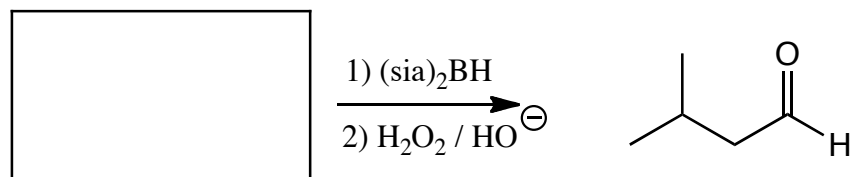

(3 or 5 pts each) Draw structures to complete the reactions. Use wedges and dashes to indicate stereochemistry and be sure to write racemic when appropriate.

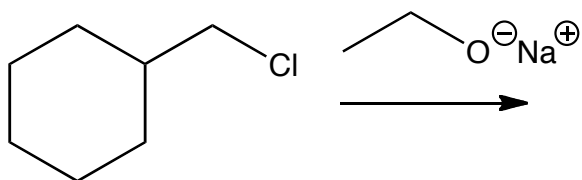
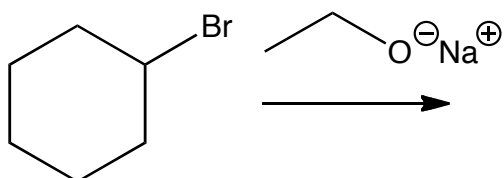
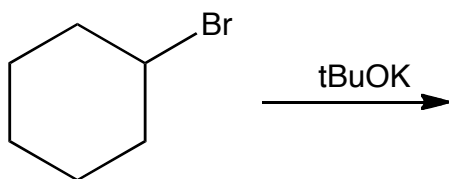
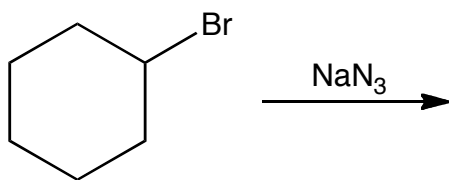
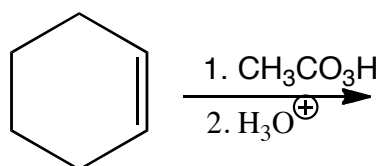
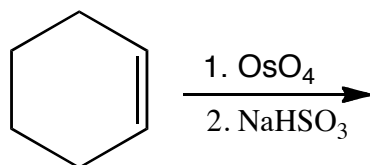
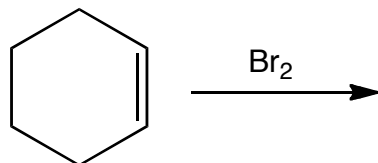

(3 or 5 pts each) Draw structures to complete the reactions. Use wedges and dashes to indicate stereochemistry and be sure to write racemic when appropriate.

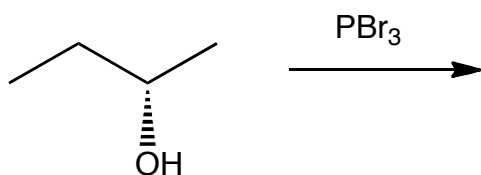
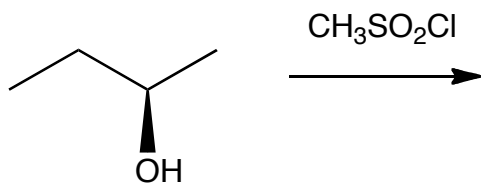
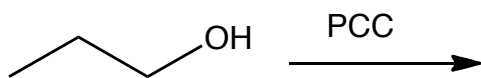
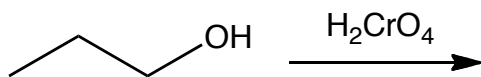
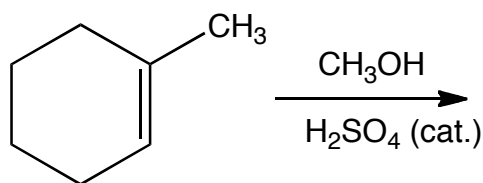
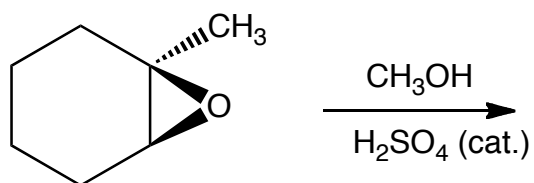
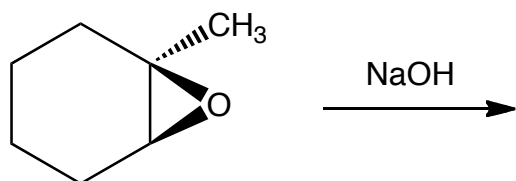

(3 or 5 pts each) Draw structures in the boxes to complete the reactions. Use wedges and dashes to indicate stereochemistry and be sure to write racemic when appropriate.

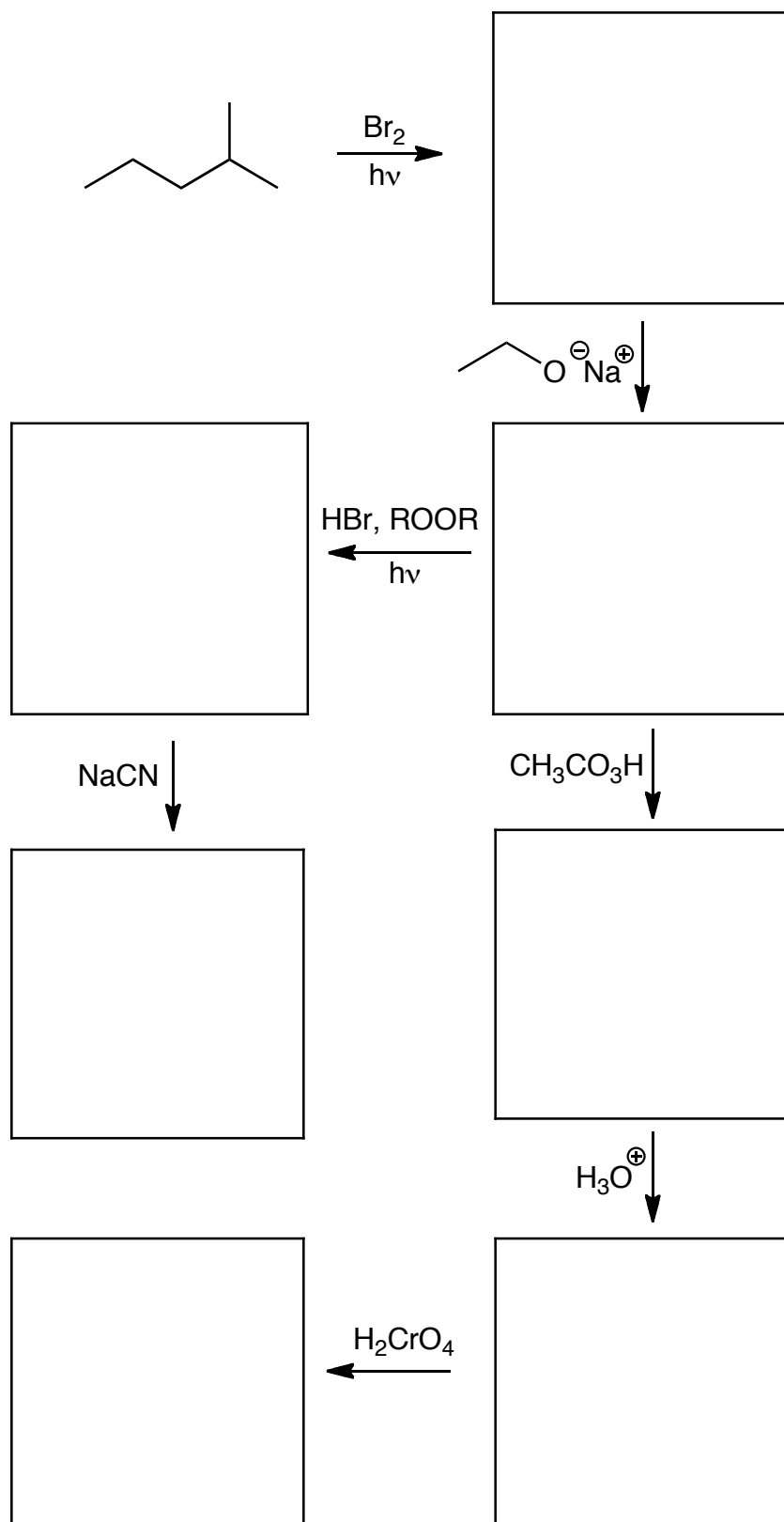

(3 pts each) Fill in the boxes with the structures that complete the reactions. Use wedges and dashes to indicate stereochemistry when appropriate. This format is intended to get you more comfortable with working backwards in synthesis problems.

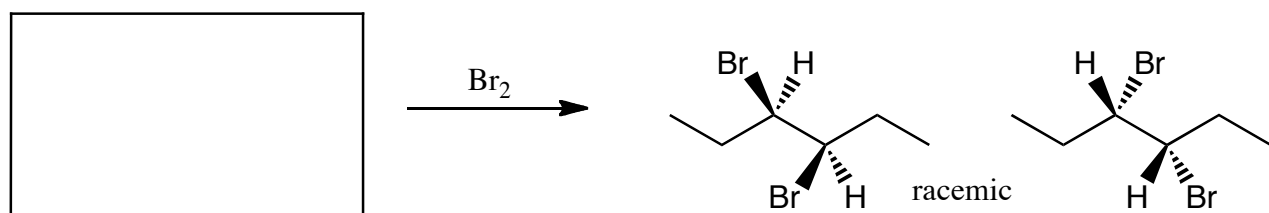
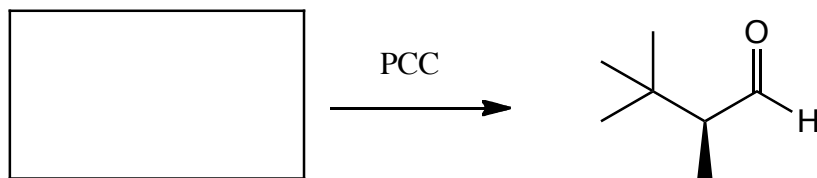
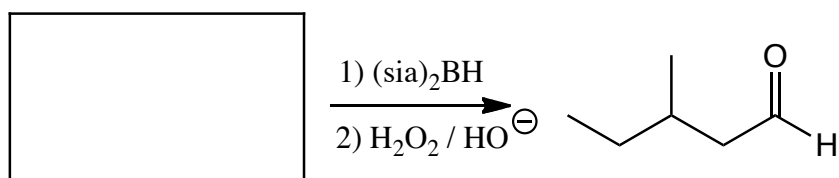
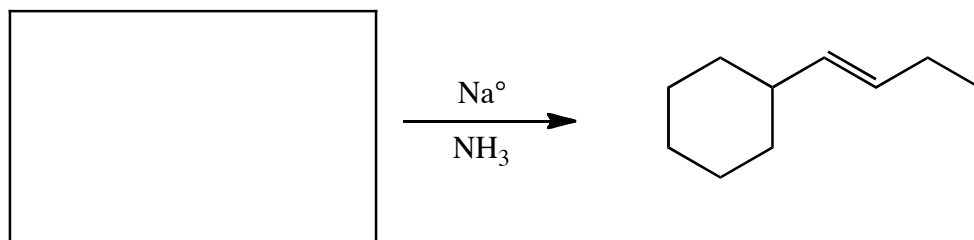
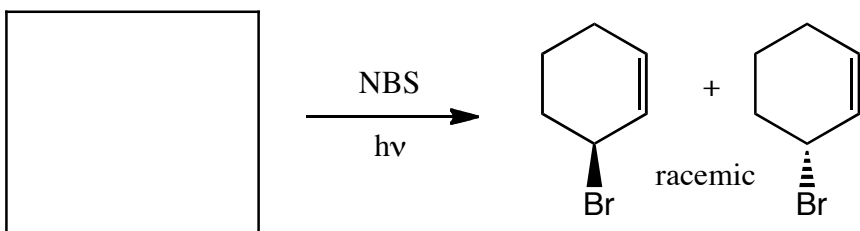
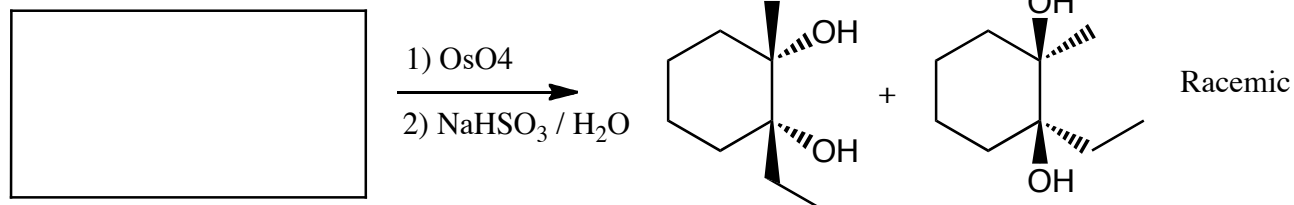
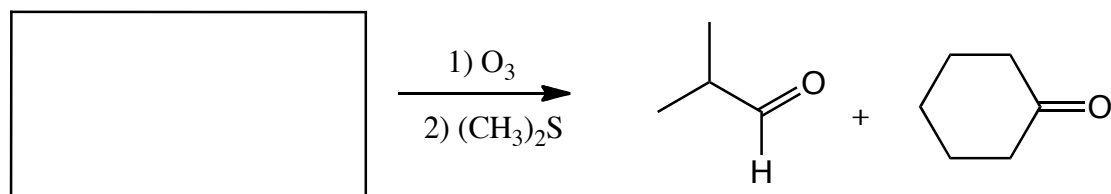

(7-9 pts each) Draw structures for the product(s) of the following series of reactions. Use wedges and dashes to indicate stereochemistry when appropriate. This format is intended to get you more comfortable with working backwards in synthesis problems.

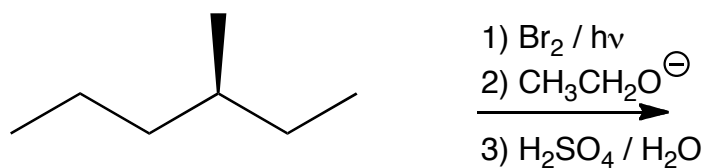
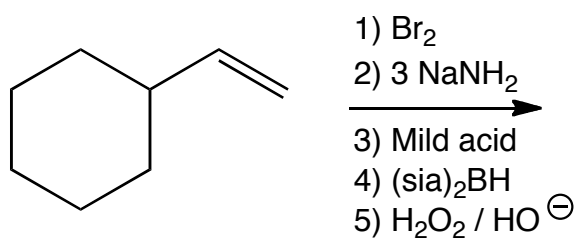
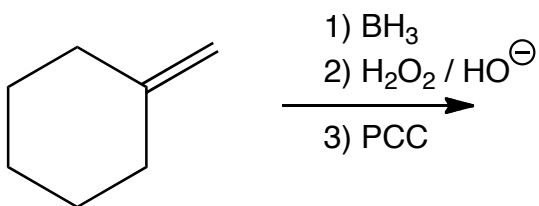

These are synthesis questions. You need to show how the starting material can be converted into the product(s) shown. You may use any reactions we have learned. Show all the reagents you need. Show each molecule synthesized along the way and be sure to pay attention to the regiochemistry and stereochemistry preferences for each reaction.

Remember, when doing synthesis problems you should 1) count carbon atoms in the product and starting material(s), 2) work backwards and 3) RECOGNIZE key features of a molecule that help you predict the reaction used to construct it.

(10 pts)

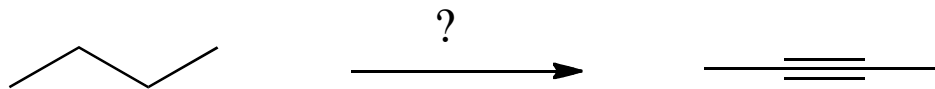

You need to show how the starting material can be converted into the product(s) shown. You may use any reactions we have learned. Show all the reagents you need. Show each molecule synthesized along the way and be sure to pay attention to the regiochemistry and stereochemistry preferences for each reaction.

(7 pts)

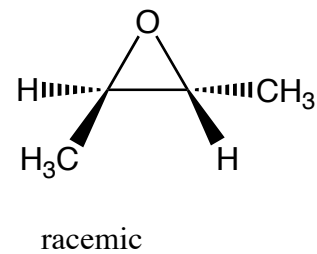
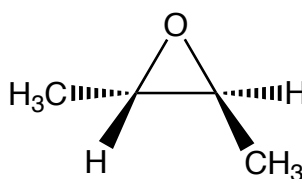
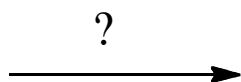
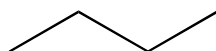

You need to show how the starting material can be converted into the product(s) shown. You may use any reactions we have learned. Show all the reagents you need. Show each molecule synthesized along the way and be sure to pay attention to the regiochemistry and stereochemistry preferences for each reaction.

(4 pts.)

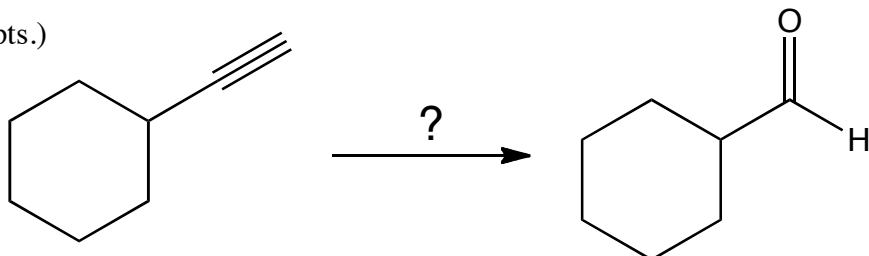

(9 pts.)

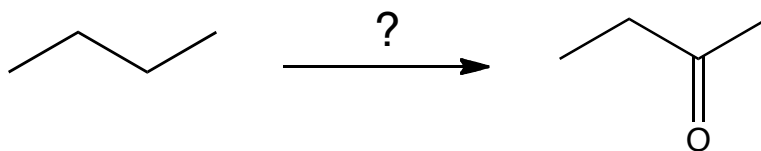

You need to show how the starting material can be converted into the product(s) shown. You may use any reactions we have learned. Show all the reagents you need. Show each molecule synthesized along the way and be sure to pay attention to the regiochemistry and stereochemistry preferences for each reaction. All of the carbon atoms of the product must come from the starting material.

(21 pts)

